

MACHINE SPACE
2 EXISTING FURNACES

Drawn by
AGW

Date:
12/13/2013

Scale:

DWG Size

Revision

SHEET

A6.02

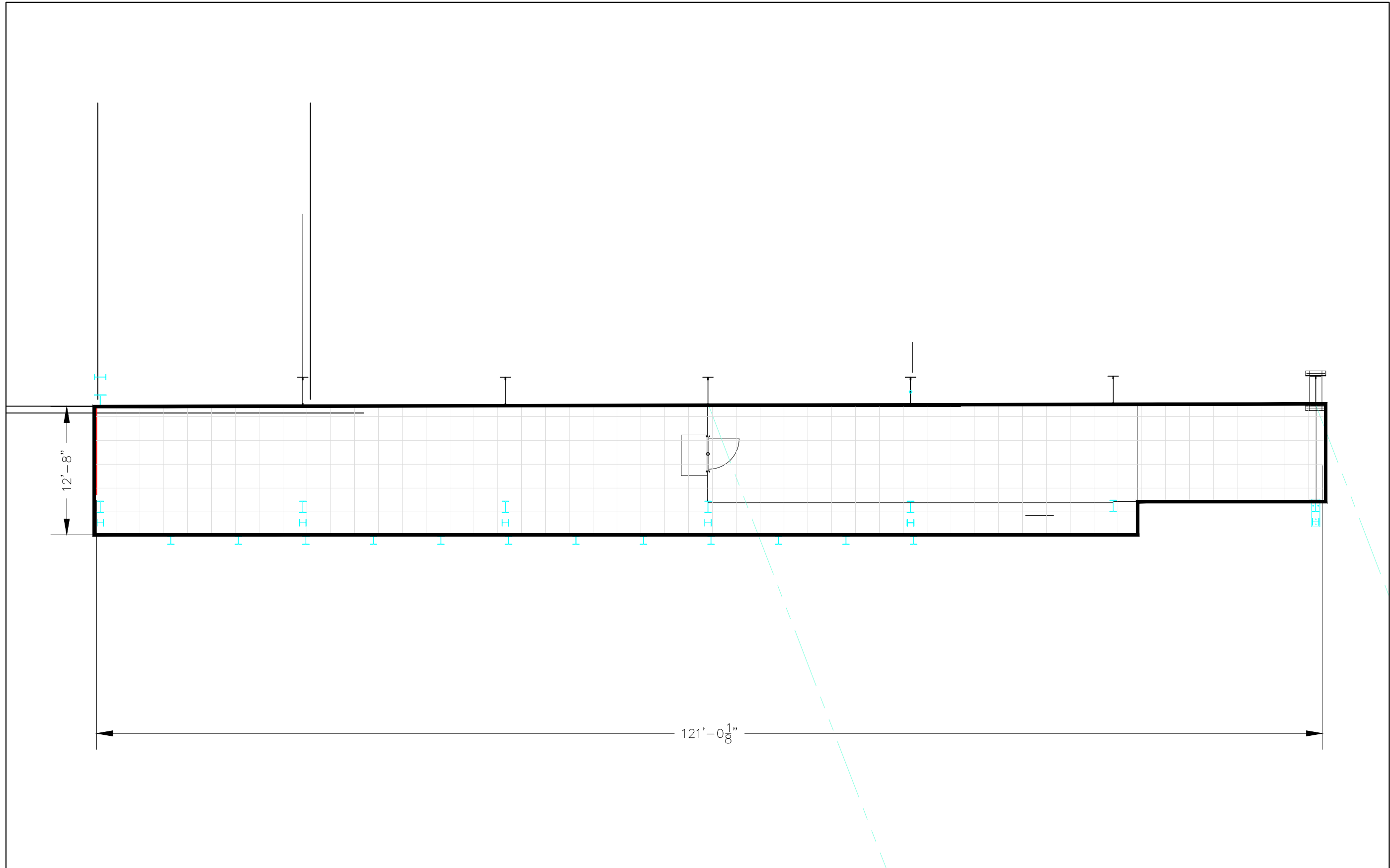

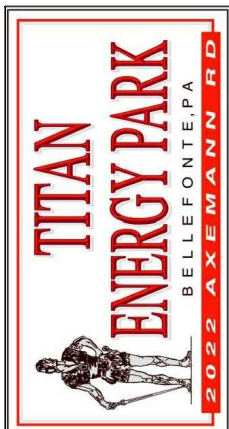
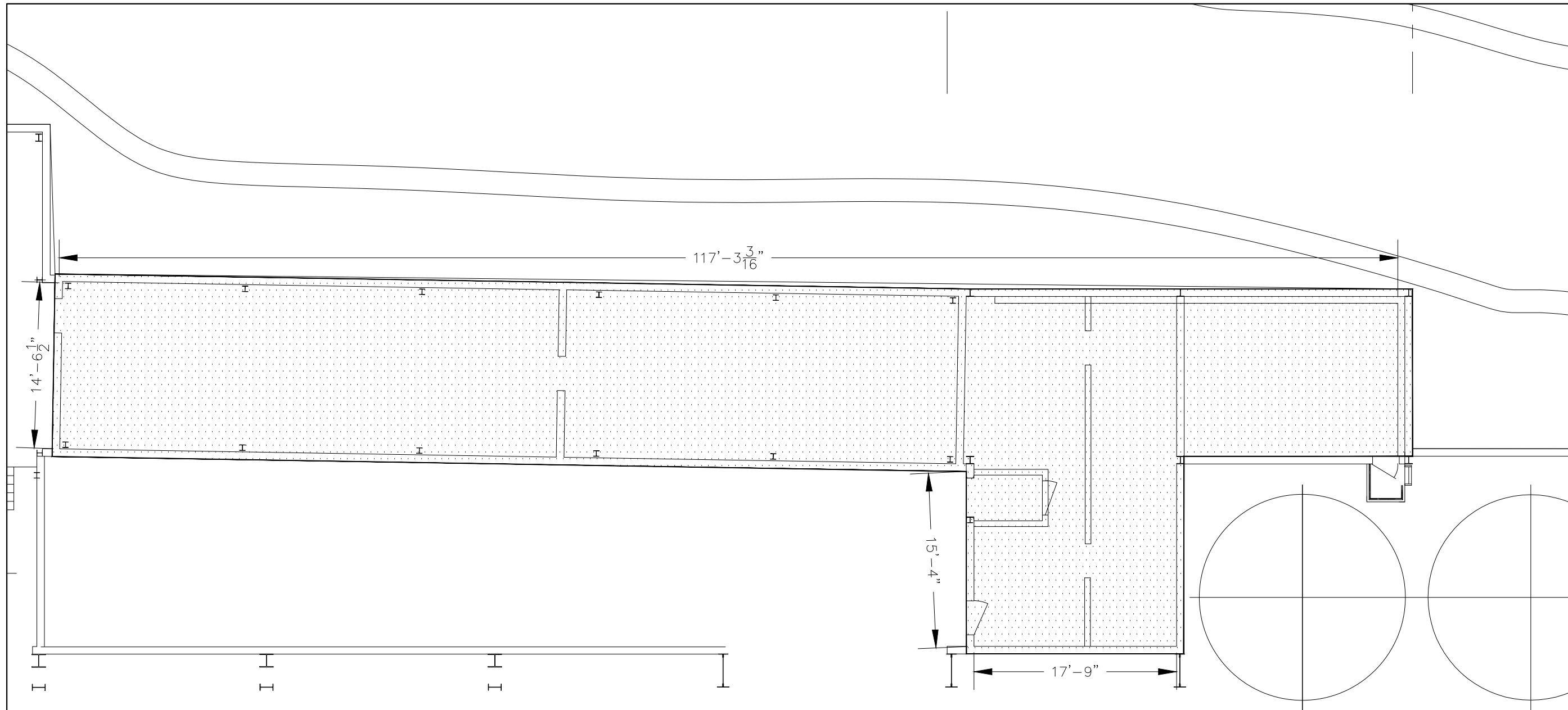

2 FLOOR LAB/
OFFICE SPACE

Drawn by
AGW

Date:
12/13/2013

Scale:

DWG Size

Revision

SHEET

A6.03

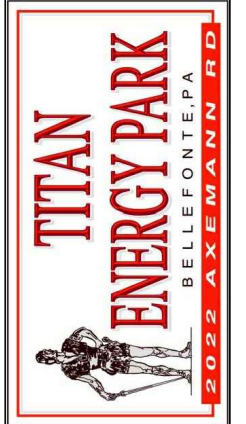
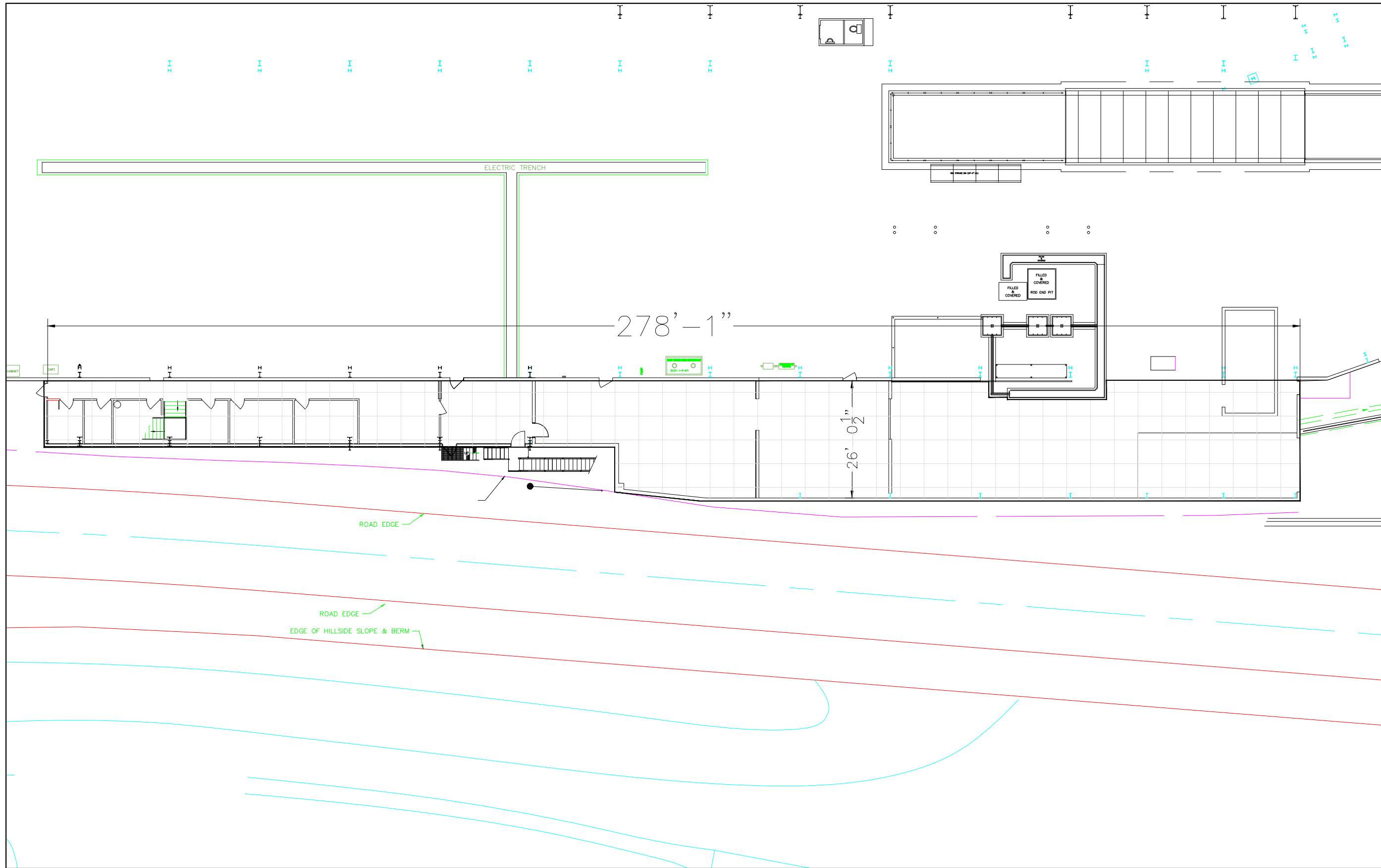

MACHINE / OFFICE SPACE
TORIT EXHAUST SYSTEM

Drawn by
AGW

Date:
12/13/2013

Scale:

DWG Size

Revision

SHEET
A6.04

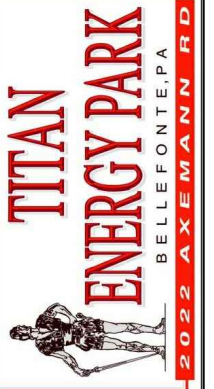
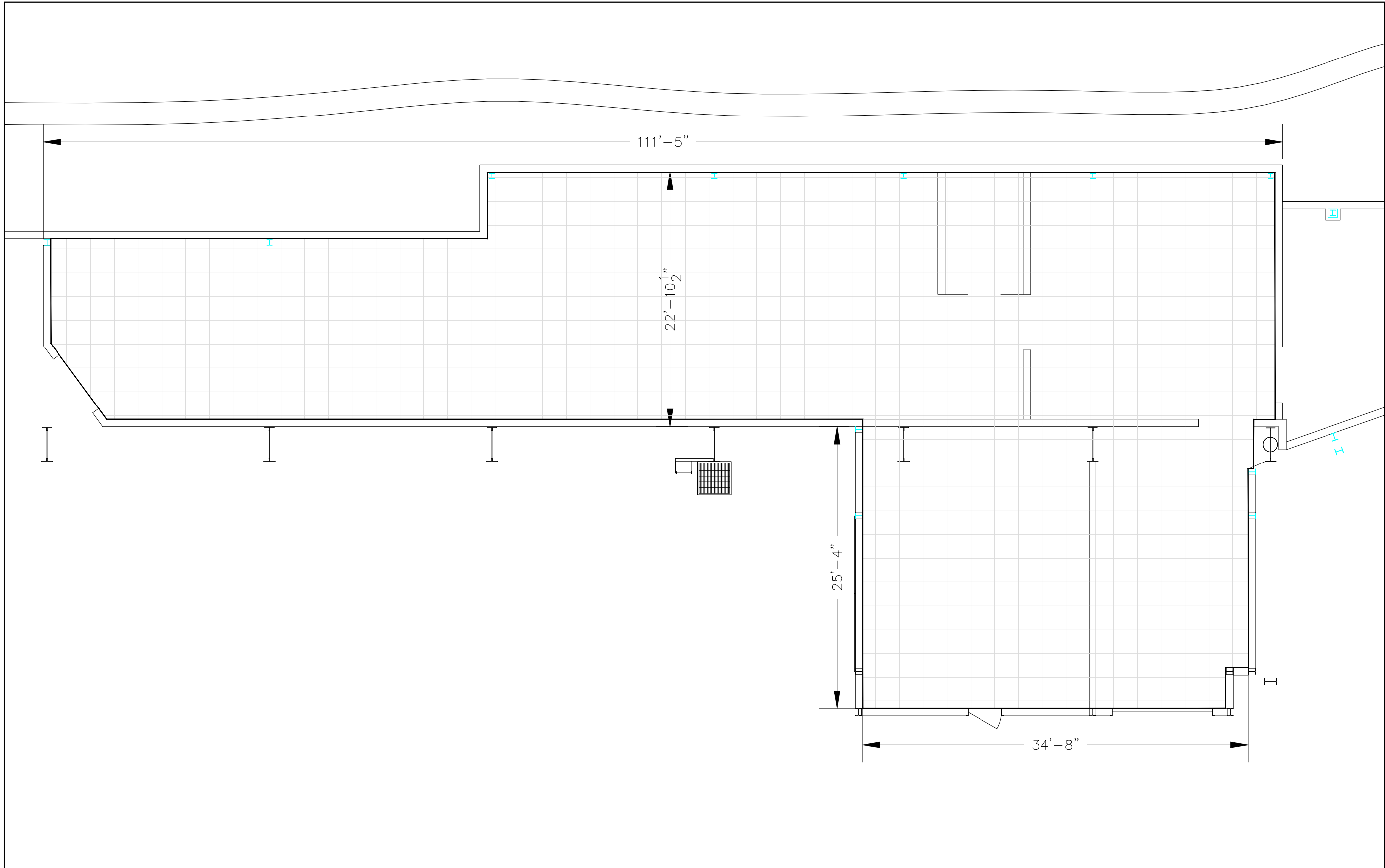

MACHINE / MANUFACTURING
SPACE
TORIT BAG HOUSE

Drawn by
AGW

Date:
12/13/2013

Scale:

DWG Size

Revision

SHEET

A6.05

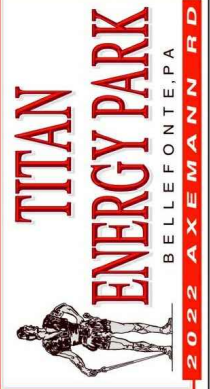
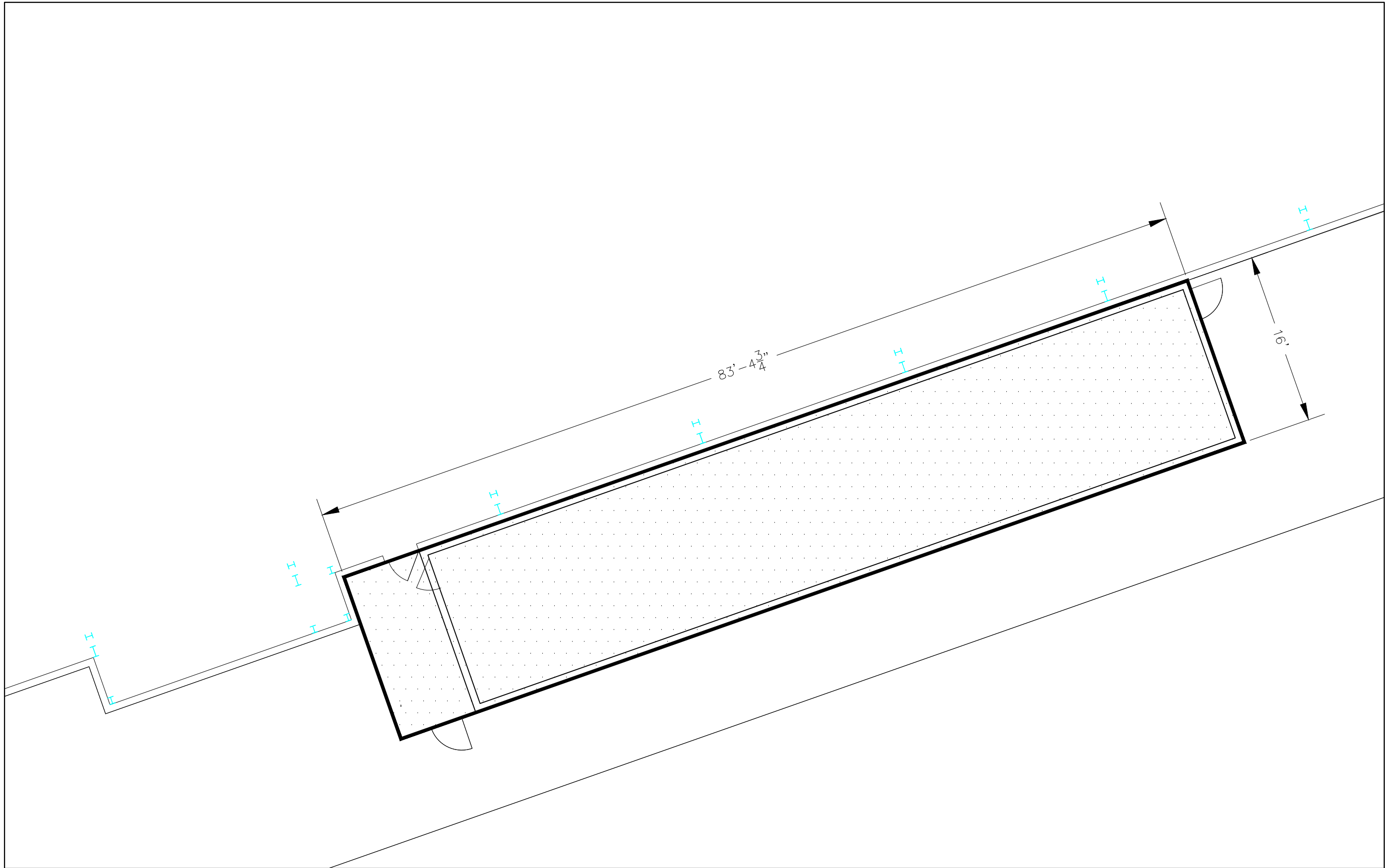

MACHINE / MANUFACTURING
SPACE
TORIT BAG HOUSE

Drawn by
AGW

Date:
12/13/2013

Scale:

DWG Size

Revision

SHEET

A6.06

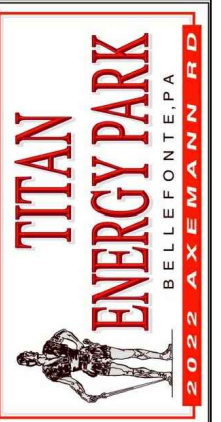

MACHINE / OFFICE SPACE

Drawn by
AGW

Date:
12/13/2013

Scale:

DWG Size

Revision

SHEET

A6.07

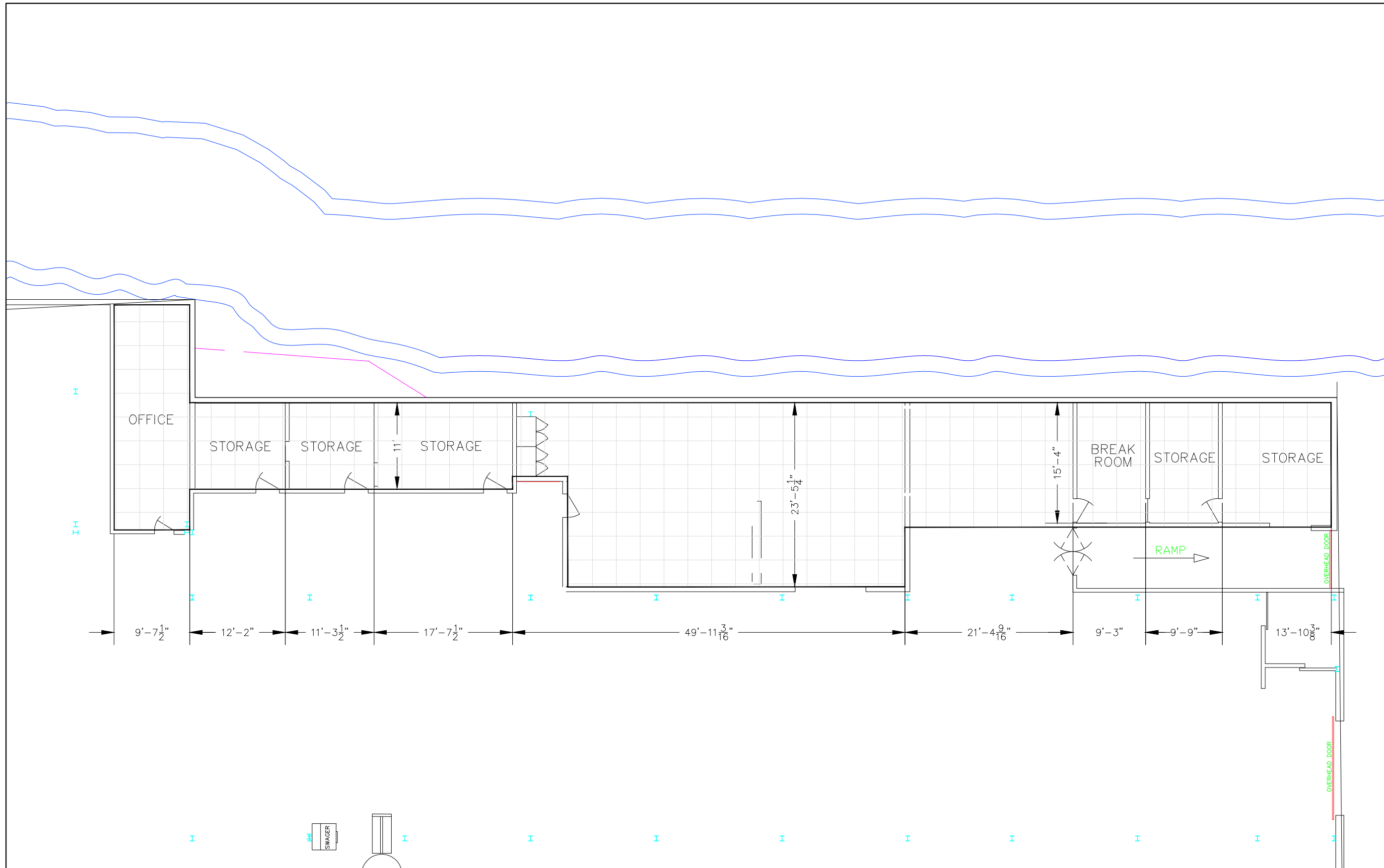

LOGAN BRANCH CREEK

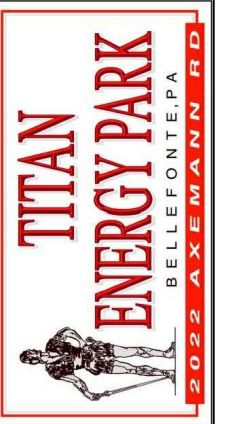
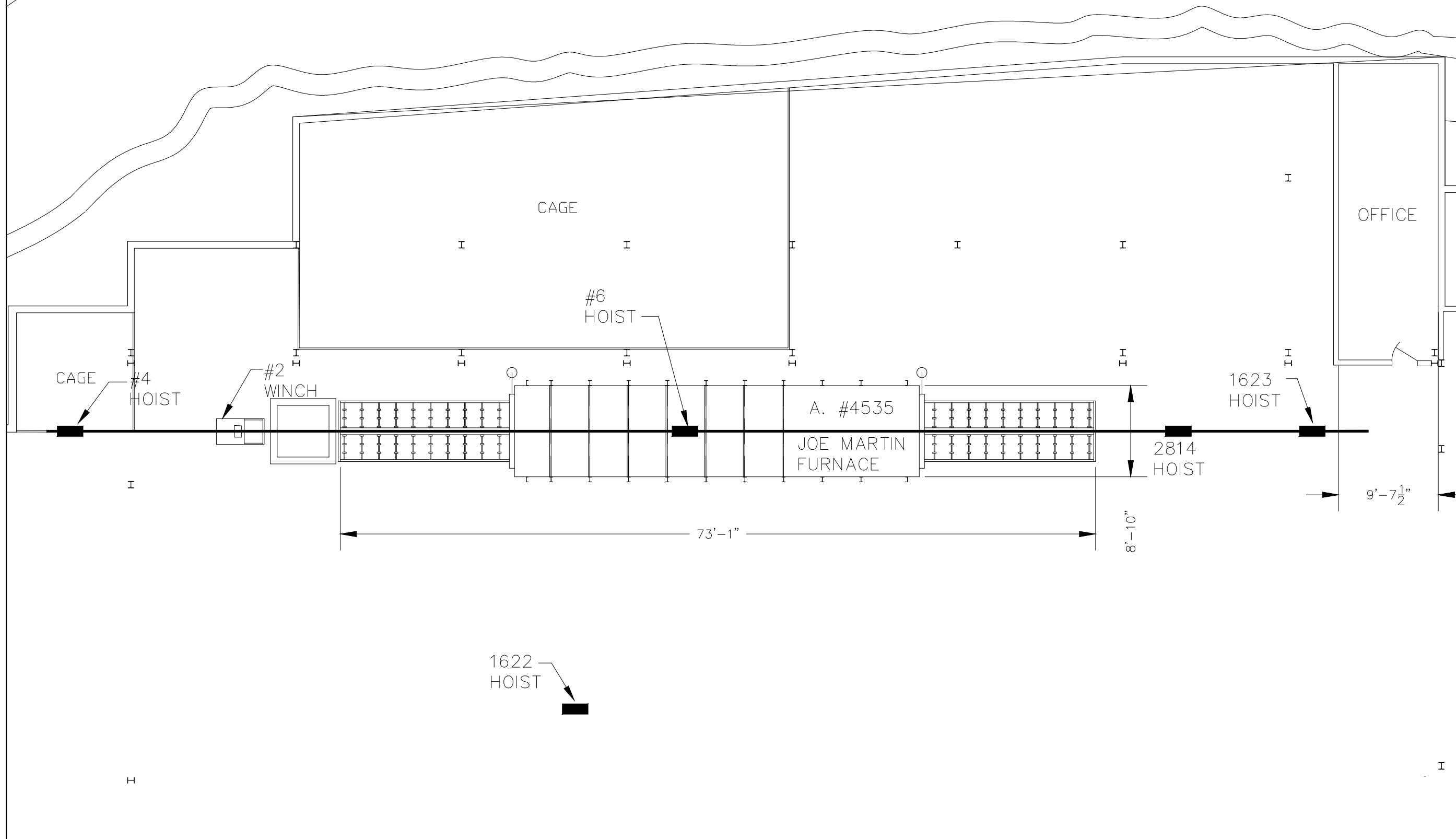

ANNEALING OVEN

Drawn by
AGW

Date:
12/13/2013

Scale:

DWG Size

Revision

SHEET

A6.08

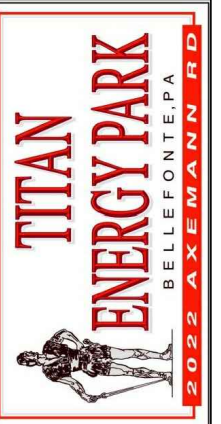
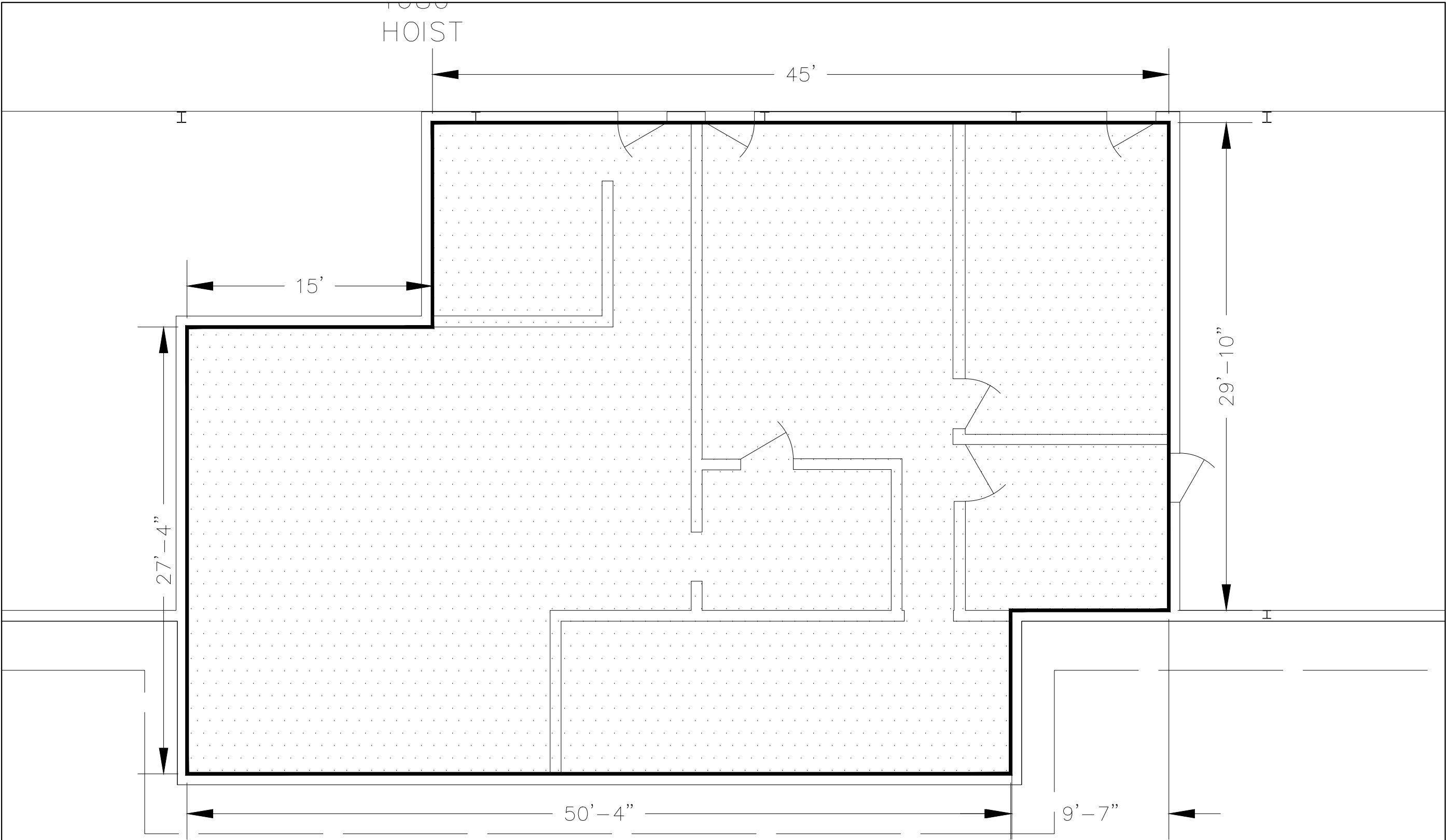

LAB/ OFFICE SPACE

Drawn by
AGW

Date:
12/13/2013

Scale:

DWG Size

Revision

SHEET

A6.09

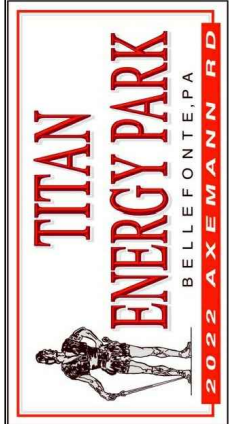
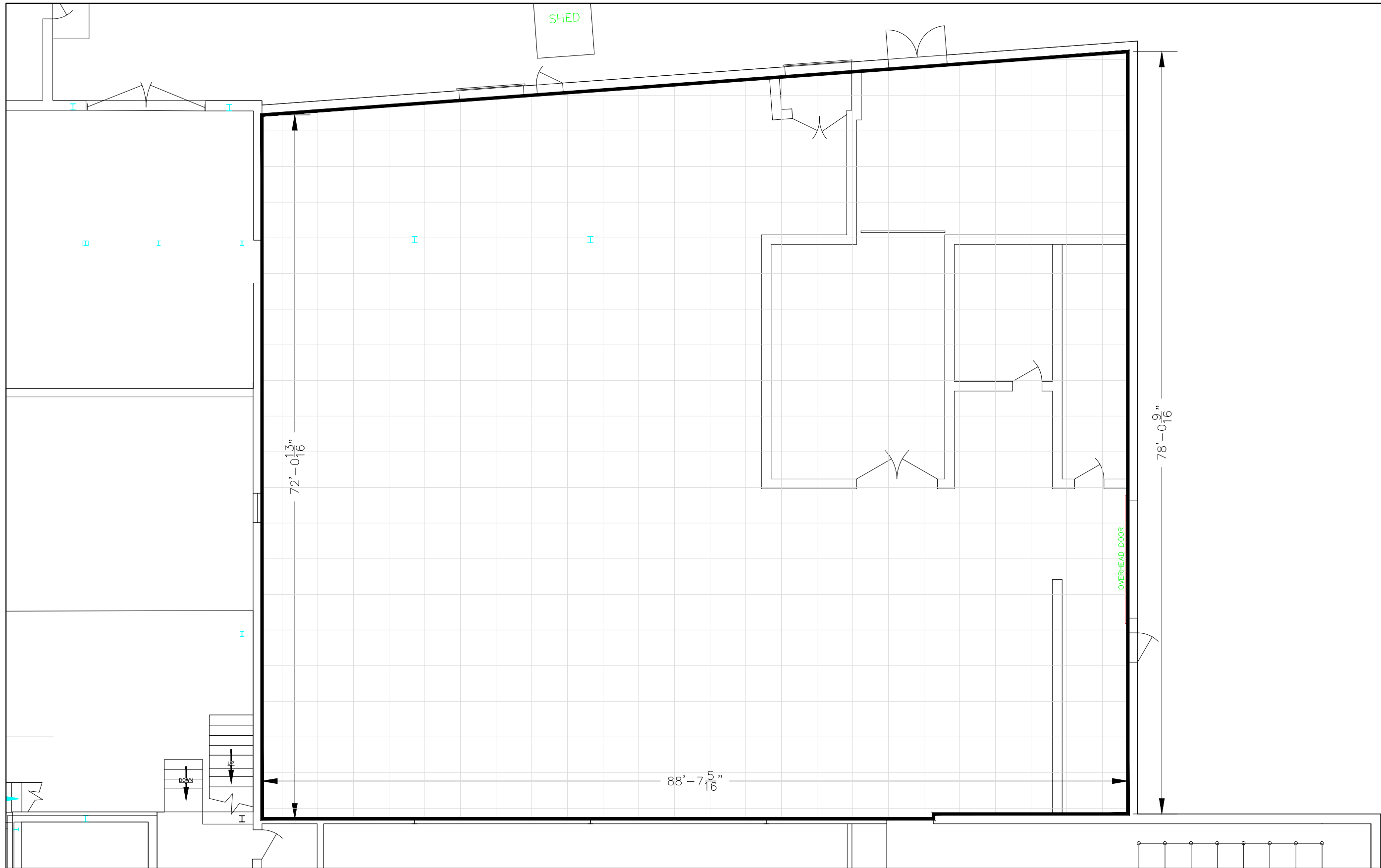

LARGE MACHINE SPACE

Drawn by
AGW

Date:
12/13/2013

Scale:

DWG Size

Revision

SHEET
A6.10

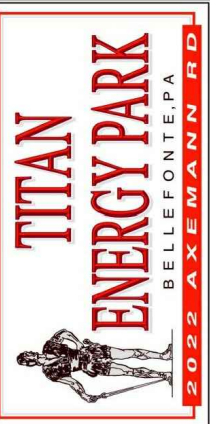

LARGE MACHINE SPACE

Drawn by
AGW

Date:
12/13/2013

Scale:

DWG Size

Revision

SHEET

A6.11

